

# Facelift Fair & Square

---

LOUNGE / TANDEM / BENCHES / TABLES

Effective: March 1, 2025

T R I N I T Y

**Date:**

**Page:**

**Modification:**

**Description:**

---

**DESCRIPTION:**

- Upholstery Frames: Plywood & Hardwood
- Seat: High Density Polyurethane Foam Over Sheet Webbing
- Upholstered Covers: Attached w/ Velcro / Removable For Maintenance
- Antimicrobial Moisture Barrier Fully Encapsulates All Foam Areas
- Ganging Straps Standard
- Brushed Aluminum Round Legs / Removable For Maintenance
- Leather Upholstery Is Available
- Lifetime Warranty

**OPTIONS:**

- USB-1 USB In Back (2 Ports Available - Specify Left or Right Facing).....\$238
- PM2 Power Module (1-Power - Specify Left or Right Facing).....\$238

Feather Down & Polyester Pillows Available (See Page 5)

**NOTE: Additional Seaming May Be Required If Fabric Is Railroaded.**

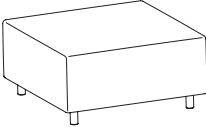
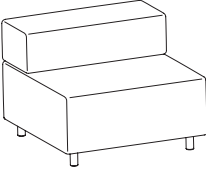
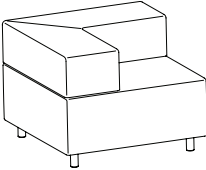
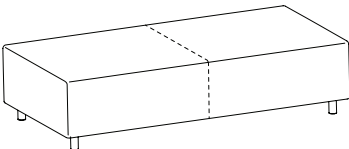
TANDEM		ITEM #:	SPECIFICATIONS   GRADES   LIST PRICES:													
			<b>Overall:</b> 36"w 36"d 18"h			<b>Arm:</b> n/a			<b>COM:</b> 2.5 yds.							
			<b>Seat:</b> 36"w 36"d 18"h			<b>Weight:</b> 62 lbs.			<b>COL:</b> 45 sq.ft.							
			<b>COM</b>	<b>COL</b>	<b>1</b>	<b>2</b>	<b>3</b>	<b>4</b>	<b>5</b>	<b>6</b>	<b>7</b>	<b>8</b>	<b>9</b>	<b>10</b>	<b>L1</b>	<b>L2</b>
	<b>1550</b>		1051	1156	1195	1296	1397	1498	1599	1700	1801	1902	2004	2105	2199	2563
			<i>Tight Seat / Removable Upholstery / 500 lb. Weight Capacity</i>													
	<b>1550-R</b>		135	148	269	341	412	483	554	625	696	767	839	910	975	1231
			<i>Replacement Upholstery Covers</i>													
			<b>Overall:</b> 36"w 36"d 28"h			<b>Arm:</b> n/a			<b>COM:</b> 3.25 yds.							
			<b>Seat:</b> 36"w 22"d 18"h			<b>Weight:</b> 70 lbs.			<b>COL:</b> 59 sq.ft.							
			<b>COM</b>	<b>COL</b>	<b>1</b>	<b>2</b>	<b>3</b>	<b>4</b>	<b>5</b>	<b>6</b>	<b>7</b>	<b>8</b>	<b>9</b>	<b>10</b>	<b>L1</b>	<b>L2</b>
	<b>1551</b>		1461	1607	1555	1641	1728	1815	1901	1988	2074	2161	2248	2334	2428	2740
			<i>Tight Seat &amp; Back / Removable Upholstery / 500 lb. Weight Capacity</i>													
	<b>1551-R</b>		184	203	364	459	554	648	743	838	933	1028	1123	1218	1304	1645
			<i>Replacement Upholstery Covers</i>													
			<b>Overall:</b> 36"w 36"d 28"h			<b>Arm:</b> n/a			<b>COM:</b> 4 yds.							
			<b>Seat:</b> 36"w 22"d 18"h			<b>Weight:</b> 74 lbs.			<b>COL:</b> 72 sq.ft.							
			<b>COM</b>	<b>COL</b>	<b>1</b>	<b>2</b>	<b>3</b>	<b>4</b>	<b>5</b>	<b>6</b>	<b>7</b>	<b>8</b>	<b>9</b>	<b>10</b>	<b>L1</b>	<b>L2</b>
	<b>1552</b>		1673	1840	1798	1906	2014	2123	2231	2339	2447	2556	2664	2772	2892	3281
			<i>Tight Seat &amp; Back / Removable Upholstery / 500 lb. Weight Capacity</i>													
	<b>1552-R</b>		243	267	467	585	704	822	941	1059	1178	1297	1415	1534	1645	2072
			<i>Replacement Upholstery Covers</i>													
			<b>Overall:</b> 72"w 36"d 18"h			<b>Arm:</b> n/a			<b>COM:</b> 4.5 yds.							
			<b>Seat:</b> 72"w 36"d 18"h			<b>Weight:</b> 121 lbs.			<b>COL:</b> 81 sq.ft.							
			<b>COM</b>	<b>COL</b>	<b>1</b>	<b>2</b>	<b>3</b>	<b>4</b>	<b>5</b>	<b>6</b>	<b>7</b>	<b>8</b>	<b>9</b>	<b>10</b>	<b>L1</b>	<b>L2</b>
	<b>1555</b>		1525	1677	1687	1809	1932	2055	2177	2300	2423	2545	2668	2791	2909	3351
			<i>Tight Seat / Removable Upholstery / 750 lb. Weight Capacity</i>													
	<b>1555-R</b>		208	229	465	599	734	868	1003	1137	1271	1406	1540	1674	1787	2271
			<i>Replacement Upholstery Covers</i>													

**DESCRIPTION:**

- Upholstery Frames: Plywood & Hardwood
- Seat: High Density Polyurethane Foam Over Sheet Webbing
- Upholstered Covers: Attached w/ Velcro / Removable For Maintenance
- Antimicrobial Moisture Barrier Fully Encapsulates All Foam Areas
- Ganging Straps Standard
- Brushed Aluminum Round Legs / Removable For Maintenance
- Leather Upholstery Is Available
- Lifetime Warranty

**OPTIONS:**

- USB-1 USB In Back (2 Ports Available - Specify Left or Right Facing).....\$238
- PM2 Power Module (1-Power - Specify Left or Right Facing).....\$238

Feather Down & Polyester Pillows Available (See Page 5)

**NOTE: Additional Seaming May Be Required If Fabric Is Railroaded.**

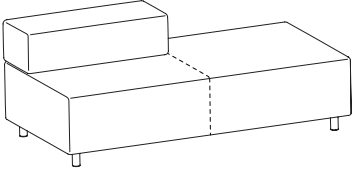
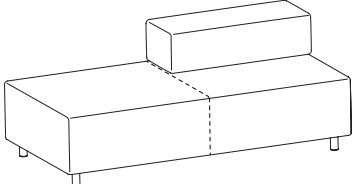
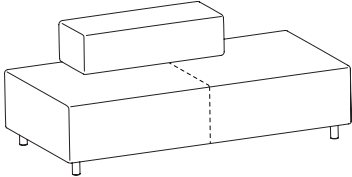
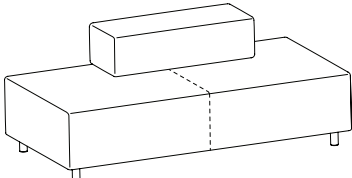
TANDEM		ITEM #:	SPECIFICATIONS   GRADES   LIST PRICES:													
			<b>Overall:</b> 72"w 36"d 28"h			<b>Arm:</b> n/a			<b>COM:</b> 5.25 yds.							
			<b>Seat:</b> 72"w 22"/36"d 18"h			<b>Weight:</b> 129 lbs.			<b>COL:</b> 95 sq.ft.							
			<b>COM</b>	<b>COL</b>	<b>1</b>	<b>2</b>	<b>3</b>	<b>4</b>	<b>5</b>	<b>6</b>	<b>7</b>	<b>8</b>	<b>9</b>	<b>10</b>	<b>L1</b>	<b>L2</b>
	<b>1556</b>		2063	2269	2239	2383	2527	2672	2816	2960	3105	3249	3393	3538	3683	4203
			<i>Tight Seat &amp; Back / Removable Upholstery / 750 lb. Weight Capacity</i>													
	<b>1556-R</b>		271	298	573	731	889	1047	1205	1363	1521	1679	1837	1995	2131	2700
			<i>Replacement Upholstery Covers</i>													
			<b>Overall:</b> 72"w 36"d 28"h			<b>Arm:</b> n/a			<b>COM:</b> 5.25 yds.							
			<b>Seat:</b> 72"w 22"/36"d 18"h			<b>Weight:</b> 129 lbs.			<b>COL:</b> 95 sq.ft.							
			<b>COM</b>	<b>COL</b>	<b>1</b>	<b>2</b>	<b>3</b>	<b>4</b>	<b>5</b>	<b>6</b>	<b>7</b>	<b>8</b>	<b>9</b>	<b>10</b>	<b>L1</b>	<b>L2</b>
	<b>1557</b>		2063	2269	2239	2383	2527	2672	2816	2960	3105	3249	3393	3538	3683	4203
			<i>Tight Seat &amp; Back / Removable Upholstery / 750 lb. Weight Capacity</i>													
	<b>1557-R</b>		271	298	573	731	889	1047	1205	1363	1521	1679	1837	1995	2131	2700
			<i>Replacement Upholstery Covers</i>													
			<b>Overall:</b> 72"w 36"d 28"h			<b>Arm:</b> n/a			<b>COM:</b> 5.25 yds.							
			<b>Seat:</b> 72"w 22"d 18"h			<b>Weight:</b> 129 lbs.			<b>COL:</b> 95 sq.ft.							
			<b>COM</b>	<b>COL</b>	<b>1</b>	<b>2</b>	<b>3</b>	<b>4</b>	<b>5</b>	<b>6</b>	<b>7</b>	<b>8</b>	<b>9</b>	<b>10</b>	<b>L1</b>	<b>L2</b>
	<b>1558</b>		2069	2276	2245	2389	2533	2678	2822	2966	3110	3255	3399	3543	3689	4208
			<i>Tight Seat &amp; Back / Removable Upholstery / 750 lb. Weight Capacity</i>													
	<b>1558-R</b>		271	298	573	731	889	1047	1205	1363	1521	1679	1837	1995	2131	2700
			<i>Replacement Upholstery Covers</i>													
			<b>Overall:</b> 72"w 36"d 28"h			<b>Arm:</b> n/a			<b>COM:</b> 5.25 yds.							
			<b>Seat:</b> 72"w 22"d 18"h			<b>Weight:</b> 129 lbs.			<b>COL:</b> 95 sq.ft.							
			<b>COM</b>	<b>COL</b>	<b>1</b>	<b>2</b>	<b>3</b>	<b>4</b>	<b>5</b>	<b>6</b>	<b>7</b>	<b>8</b>	<b>9</b>	<b>10</b>	<b>L1</b>	<b>L2</b>
	<b>1559</b>		2069	2276	2245	2389	2533	2678	2822	2966	3110	3255	3399	3543	3689	4208
			<i>Tight Seat &amp; Back / Removable Upholstery / 750 lb. Weight Capacity</i>													
	<b>1559-R</b>		271	298	573	731	889	1047	1205	1363	1521	1679	1837	1995	2131	2700
			<i>Replacement Upholstery Covers</i>													

**DESCRIPTION:**

- Upholstery Frames: Plywood & Hardwood
- Seat: High Density Polyurethane Foam Over Sheet Webbing
- Upholstered Covers: Attached w/ Velcro / Removable For Maintenance
- Antimicrobial Moisture Barrier Fully Encapsulates All Foam Areas
- Ganging Straps Standard
- Brushed Aluminum Round Legs / Removable For Maintenance
- Leather Upholstery Is Available
- Lifetime Warranty

**OPTIONS:**

- USB-1 USB In Back (2 Ports Available - Specify Left or Right Facing).....\$238
- PM2 Power Module (1-Power - Specify Left or Right Facing).....\$238

Feather Down & Polyester Pillows Available (See Page 5)

**NOTE: Additional Seaming May Be Required If Fabric Is Railroaded.**

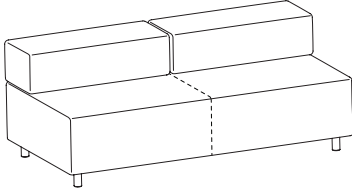
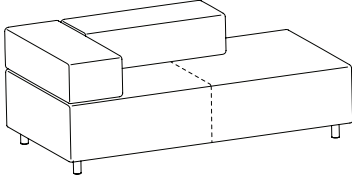
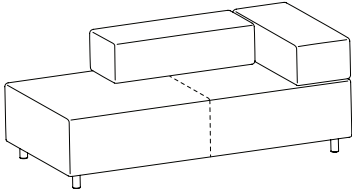
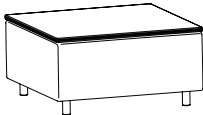
TANDEM		ITEM #:	SPECIFICATIONS   GRADES   LIST PRICES:													
			<b>Overall:</b> 72"w 36"d 28"h			<b>Arm:</b> n/a			<b>COM:</b> 6 yds.							
			<b>Seat:</b> 72"w 22"d 18"h			<b>Weight:</b> 137 lbs.			<b>COL:</b> 108 sq.ft.							
			<b>COM</b>	<b>COL</b>	<b>1</b>	<b>2</b>	<b>3</b>	<b>4</b>	<b>5</b>	<b>6</b>	<b>7</b>	<b>8</b>	<b>9</b>	<b>10</b>	<b>L1</b>	<b>L2</b>
	<b>1560</b>		2439	2683	2638	2804	2970	3136	3302	3468	3634	3800	3966	4132	4318	4915
			<i>Tight Seat &amp; Back / Removable Upholstery / 750 lb. Weight Capacity</i>													
	<b>1560-R</b>		294	323	641	823	1005	1187	1369	1550	1732	1914	2096	2277	2435	3090
			<i>Replacement Upholstery Covers</i>													
			<b>Overall:</b> 72"w 36"d 28"h			<b>Arm:</b> n/a			<b>COM:</b> 6 yds.							
			<b>Seat:</b> 72"w 22"/36"d 18"h			<b>Weight:</b> 137 lbs.			<b>COL:</b> 108 sq.ft.							
			<b>COM</b>	<b>COL</b>	<b>1</b>	<b>2</b>	<b>3</b>	<b>4</b>	<b>5</b>	<b>6</b>	<b>7</b>	<b>8</b>	<b>9</b>	<b>10</b>	<b>L1</b>	<b>L2</b>
	<b>1561</b>		2476	2724	2673	2839	3005	3171	3337	3503	3669	3835	4001	4167	4352	4950
			<i>Tight Seat &amp; Back / Removable Upholstery / 750 lb. Weight Capacity</i>													
	<b>1561-R</b>		294	323	641	823	1005	1187	1369	1550	1732	1914	2096	2277	2435	3090
			<i>Replacement Upholstery Covers</i>													
			<b>Overall:</b> 72"w 36"d 28"h			<b>Arm:</b> n/a			<b>COM:</b> 6 yds.							
			<b>Seat:</b> 72"w 22"/36"d 18"h			<b>Weight:</b> 137 lbs.			<b>COL:</b> 108 sq.ft.							
			<b>COM</b>	<b>COL</b>	<b>1</b>	<b>2</b>	<b>3</b>	<b>4</b>	<b>5</b>	<b>6</b>	<b>7</b>	<b>8</b>	<b>9</b>	<b>10</b>	<b>L1</b>	<b>L2</b>
	<b>1562</b>		2476	2724	2673	2839	3005	3171	3337	3503	3669	3835	4001	4167	4352	4950
			<i>Tight Seat &amp; Back / Removable Upholstery / 750 lb. Weight Capacity</i>													
	<b>1562-R</b>		294	323	641	823	1005	1187	1369	1550	1732	1914	2096	2277	2435	3090
			<i>Replacement Upholstery Covers</i>													
			<b>Overall:</b> 36"w 36"d 19"h			<b>Arm:</b> n/a			<b>COM:</b> 2.25 yds.							
			<b>Seat:</b> n/a			<b>Weight:</b> 103 lbs.			<b>COL:</b> 41 sq.ft.							
			<b>COM</b>	<b>COL</b>	<b>1</b>	<b>2</b>	<b>3</b>	<b>4</b>	<b>5</b>	<b>6</b>	<b>7</b>	<b>8</b>	<b>9</b>	<b>10</b>	<b>L1</b>	<b>L2</b>
	<b>1564-L</b>		1509	1659	1542	1599	1657	1715	1773	1830	1888	1946	2004	2061	2125	2333
			<i>High Pressure Laminate Face / Multi-Ply Edge</i>													
	<b>1564-R</b>		135	148	269	341	412	483	554	625	696	767	839	910	975	1231
			<i>Replacement Upholstery Covers</i>													

**DESCRIPTION:**

- High Pressure Laminate Face
- Multi-Ply Edge
- Lifetime Warranty

**OPTIONS:**

Specify Laminate (See Page 6)

TANDEM	ITEM #:	SPECIFICATIONS   GRADES   LIST PRICES:																	
<p>TABLE TOP ONLY / CAN BE SUBSTITUTED FOR ANY BACK</p> 		<p><b>Overall:</b> 36"w 14"d 1"h <b>Seat:</b> n/a</p>	<p><b>Arm:</b> n/a <b>Weight:</b> 16 lbs.</p>	<p><b>COM:</b> n/a <b>COL:</b> n/a</p>	<table border="1"> <thead> <tr> <th>COM</th> <th>COL</th> <th>1</th> <th>2</th> <th>3</th> <th>4</th> <th>5</th> <th>6</th> <th>7</th> <th>8</th> <th>9</th> <th>10</th> <th>L1</th> <th>L2</th> </tr> </thead> </table>	COM	COL	1	2	3	4	5	6	7	8	9	10	L1	L2
COM	COL	1	2	3	4	5	6	7	8	9	10	L1	L2						
	<p>T1-L</p> <p>241 <i>High Pressure Laminate Face / Multi-Ply Edge</i></p>																		

## Configuration Examples

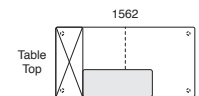
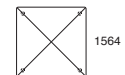
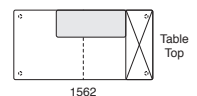
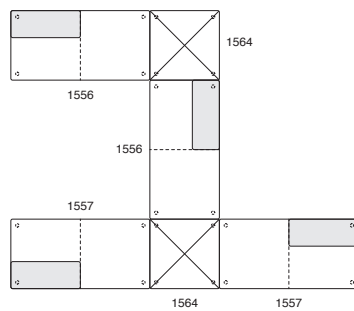
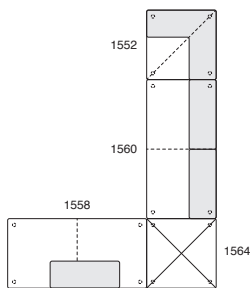
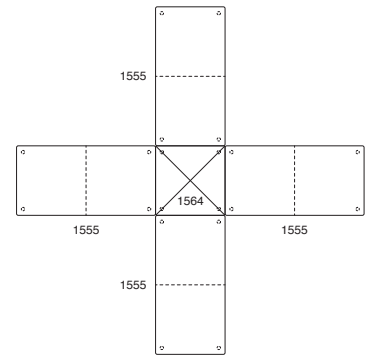
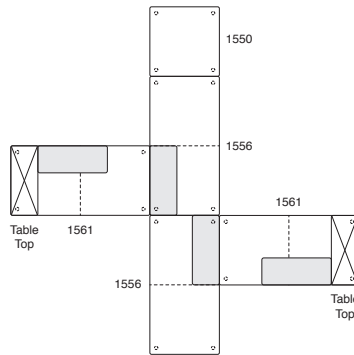
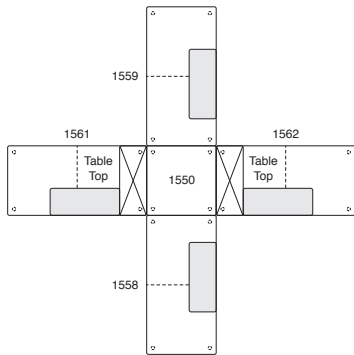
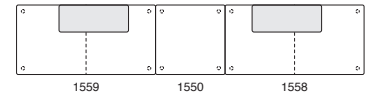
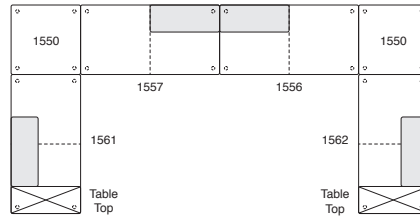
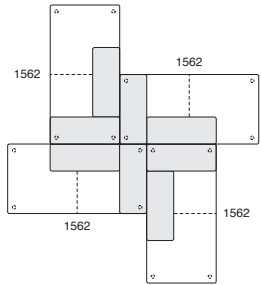
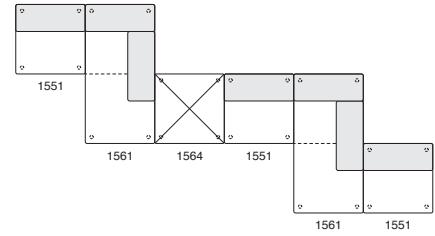
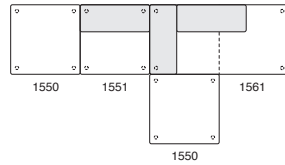
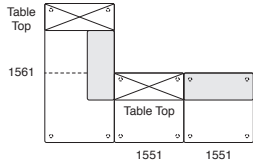

POWER / COVERS	OPTION #:	SPECIFICATIONS   LIST PRICES   AVAILABILITY:
<p>DUAL CHARGING USB</p> 	<p><b>USB-1</b></p> <p><i>Overall: 2"w 2"d .1875"h</i></p> <p>\$238 (Per Arm)  <i>Spill-Proof Technology / 2 Amps Per Port / Multiple Finish Options / Storm Color Standard (Specify Left or Right Facing)</i></p> <p><i>Available: Facelift Fair &amp; Square Collection</i></p>	
<p>POWER MODULE</p> 	<p><b>PM2</b></p> <p><i>PM2 Overall: 2"w 2"d .125"h</i></p> <p>\$238 Power Module (1-Power)  <i>Spill-Proof Technology / Multiple Finish Options / Storm Color Standard (Specify Left or Right Facing)</i></p> <p><i>Available: Facelift Fair &amp; Square Collection</i></p>	
<p>CONTRASTING COVERS</p> 	<p><b>CC</b></p> <p><i>Overall: N/A</i></p> <p>\$129  <i>NOTE: If Two Or More Upholsteries Or Leathers Are Used On Any Piece Of Furniture, Then A Contrast Charge Will Apply Per Order. When Using Trinity Upholstery, The Higher Priced Upholstery Grade Will Be Used In Pricing, Unless It's Trinity Leather With Fabric Contrast Welt, Or COM With Trinity Contrast Welt, Then Contact Customer Service For Pricing.</i></p> <p><i>Available: Facelift Fair &amp; Square Collection</i></p>	